



NAME: LED VAPOR LIGHT

P/N: SNC-TP12-45WA1

Advantage

- UL、CUL、DLC certificate
- IP65 Waterproof Rating
- Big heat sink, high CRI.
- Internal driver, input voltage AC100-277V.
- No UV or IR in the beam.
- Easy to install and operate.
- Energy saving, long service life.
- Light is soft and uniform, safe to eyes.
- Instant start, NO flickering, NO humming.
- Green and eco-friendly without mercury.

Application

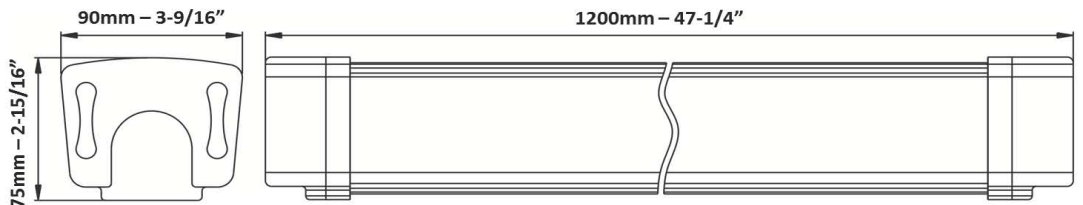

- Widely used in workshop, warehouse, cold store, parking lot, food industry, tunnel, bathroom, etc.

PRODUCT SPECIFICATIONS	
Product name	LED Tri-proof Light
Part No	SNC-TP12-45WA1
Light Type	Tri-proof Light
Dimension	1200*90*75mm
Technical Characteristic	
Cover	Frosted+Strip
Color temperature	3000K、3500K、4000K、4500K、5000K
CRI	> 80
Lumen	3800-4250 LM
Lumen Efficacy	85-95 LM/W
Input Power	45 W
Viewing Angle	120 Degree
Input Voltage	AC100-277V 50/60Hz
PFC	>90%
Waterproof Rating	IP65
MATERIALS	
LED Brand	EPISTAR
LED Type	SMD2835
LED QTY	264 PCS
Housing	PC+AL

Housing color	White+Grey
OTHERS	
Operating Temperature	-20°C TO 45°C
Operating Humidity	20%-70% RH
Storage Temperature	-30°C TO 80°C
Storage Humidity	10%-75% RH
Application	Indoor/Outdoor
Safety Certification	UL, CUL, DLC
Warranty Time	5 Years

Notice For User

- Please turn off power before install or change assembly parts.
- The input voltage and lamps should be matched, after connecting the power line, please make sure the wiring section is insulated.
- No-professionals, must not install and disassemble the lamps.

Trouble Shooting

Troubles	Check points
Flickering of the light	Turn off the power and turn on again in 3 minutes. If same phenomena occur, then call agencies
Out of working	Please check the connection

Installation steps

1. Drill hole 4PCS in the plate, size W=26MM, size L according to the length of LED tri-proof light.
2. Knock 4PCS setscrew into the holes.
3. The stator is fixed on the setscrew with 4PCS tapping screw.
4. Embed the LED tri-proof light into the stator.
5. Connected with the power and turn on.

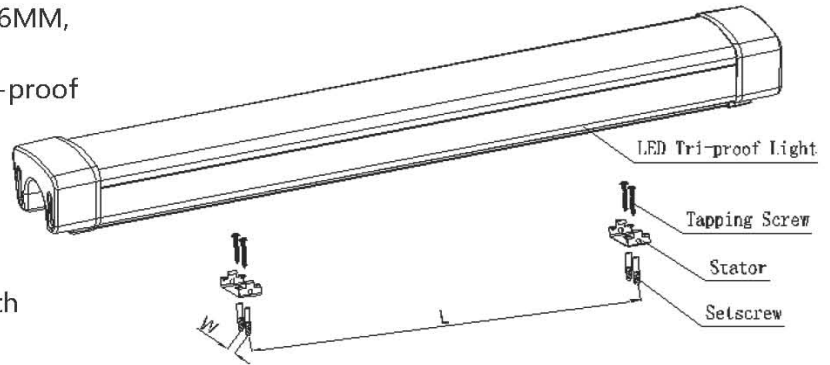

IES test

DATA OF LAMP		PHOTOMETRIC DATA				Eff: 92.92 lm/W
MODEL		I _{max} (cd)	1389	S/MH (C0/180)		1.27
NOMINAL POWER (W)	45	LOR (%)	100.0	S/MH (C90/270)		1.26
RATED VOLTAGE (V)	220	TOTAL FLUX (lm)	4035.1	η UP, DN (C0-180)		0.0, 48.6
NOMINAL FLUX (lm)	4035.1	CIE CLASS	DIRECT	η UP, DN (C180-360)		0.0, 51.4
LAMPS INSIDE	1	η up (%)	0.0	CIBSE SHR NOM		1.25
TEST VOLTAGE (V)	220	η down (%)	100.0	CIBSE SHR MAX		1.35

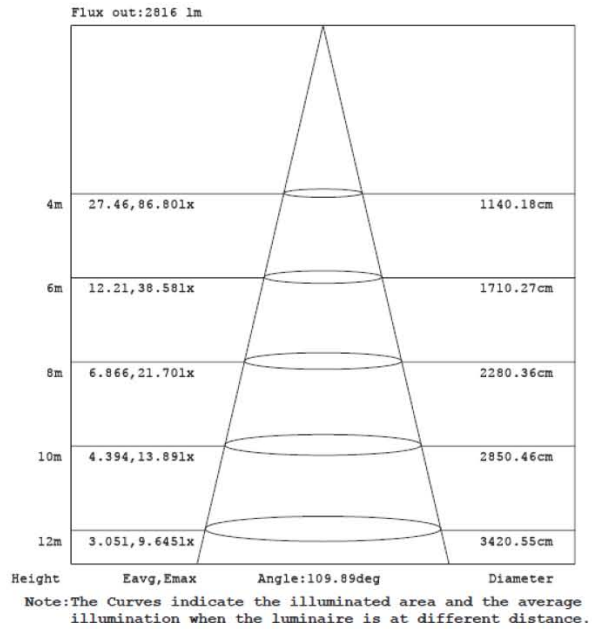
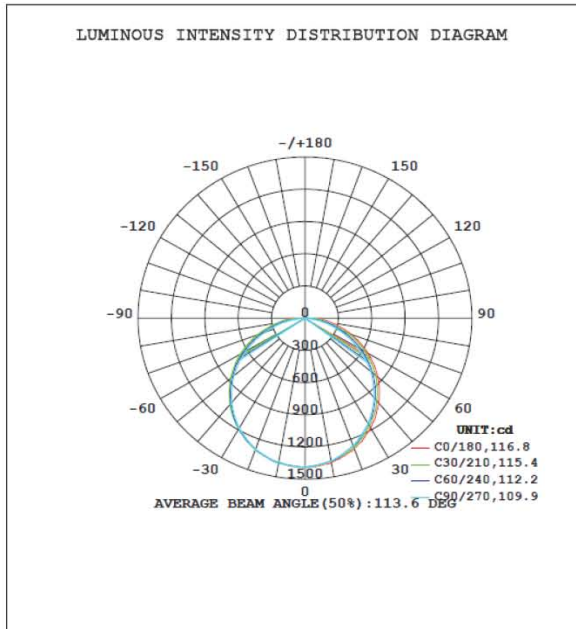

PACKAGE

	Size	Qty/ Carton	Net Weight/ Carton	Gross Weight/ Carton
Inner box	1240*95*80 MM	1 PC	3.0 KG	3.4 KG
Outer box	1255*255*220 MM	6 PCS	18.0 KG	21.6 KG

LED Tri-proof Light

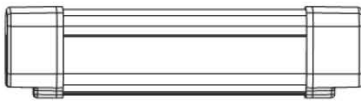

Into PE bag

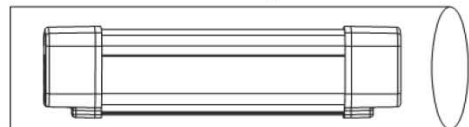

Into outer box

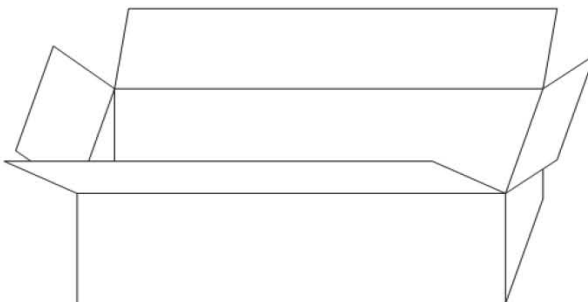

Into inner box

